

**HACIENDA**  
MAMAGREEN Design Lab









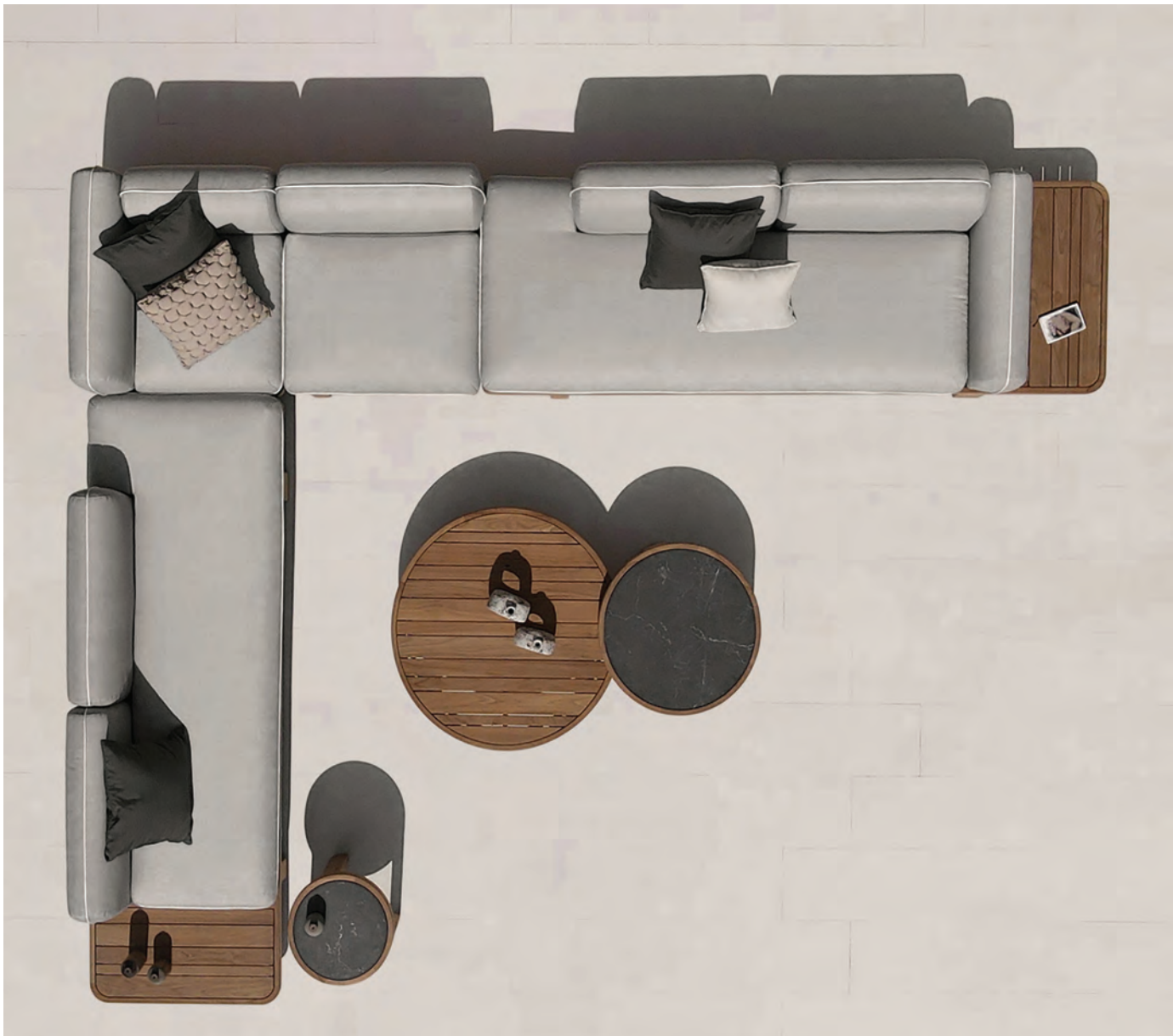



**HACIENDA 2-SEATER**

HAC16

<b>W</b>	83"	210 cm	<b>Unit</b>	1 / Box
<b>D</b>	33.5"	85 cm	<b>Volume</b>	48 ft <sup>3</sup> 1.37 m <sup>3</sup>
<b>H</b>	27.5"	70 cm	<b>Nett</b>	99 lb 45 kg
<b>SH</b>	16"	40 cm	<b>Gross</b>	117 lb 53 kg
<b>AH</b>	22"	55 cm		



**HACIENDA 3-SEATER**

HAC17

<b>W</b>	116"	295 cm	<b>Unit</b>	Crate
<b>D</b>	33.5"	85 cm	<b>Volume</b>	98 ft <sup>3</sup> 2.78 m <sup>3</sup>
<b>H</b>	27.5"	70 cm	<b>Nett</b>	123 lb 56 kg
<b>SH</b>	16"	40 cm	<b>Gross</b>	351 lb 159 kg
<b>AH</b>	22"	55 cm		

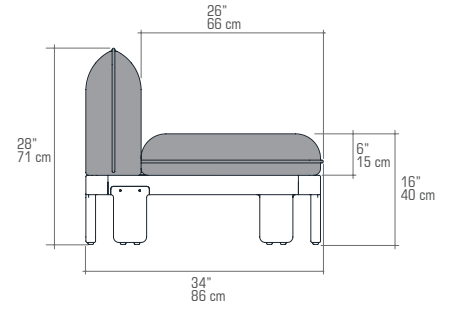

**HACIENDA Right Hand Sectional (HPL)**

HAC21

<b>W</b>	98.5"	250 cm	<b>Unit</b>	1 / Box
<b>D</b>	33.5"	85 cm	<b>Volume</b>	57 ft <sup>3</sup> 1.61 m <sup>3</sup>
<b>H</b>	27.5"	70 cm	<b>Nett</b>	101 lb 46 kg
<b>SH</b>	16"	40 cm	<b>Gross</b>	121 lb 55 kg



**HACIENDA Left Hand Sectional (HPL)**

HAC20

<b>W</b>	98.5"	250 cm	<b>Unit</b>	1 / Box
<b>D</b>	33.5"	85 cm	<b>Volume</b>	57 ft <sup>3</sup> 1.61 m <sup>3</sup>
<b>H</b>	27.5"	70 cm	<b>Nett</b>	101 lb 46 kg
<b>SH</b>	16"	40 cm	<b>Gross</b>	121 lb 55 kg



**HACIENDA Right Hand Sectional with Arm (HPL)**

HAC23

<b>W</b>	106"	270 cm	<b>Unit</b>	Crate
<b>D</b>	33.5"	85 cm	<b>Volume</b>	90 ft <sup>3</sup> 2.56 m <sup>3</sup>
<b>H</b>	27.5"	70 cm	<b>Nett</b>	110 lb 50 kg
<b>SH</b>	16"	40 cm	<b>Gross</b>	313 lb 142 kg
<b>AH</b>	22"	55 cm		



**HACIENDA Left Hand Sectional with Arm (HPL)**

HAC22

<b>W</b>	106"	270 cm	<b>Unit</b>	Crate
<b>D</b>	33.5"	85 cm	<b>Volume</b>	90 ft <sup>3</sup> 2.56 m <sup>3</sup>
<b>H</b>	27.5"	70 cm	<b>Nett</b>	110 lb 50 kg
<b>SH</b>	16"	40 cm	<b>Gross</b>	313 lb 142 kg
<b>AH</b>	22"	55 cm		



**HACIENDA Sectional Table (HPL)**

HAC19

<b>L</b>	33.5"	85 cm	<b>Unit</b>	1 / Box
<b>W</b>	33.5"	85 cm	<b>Volume</b>	6 ft <sup>3</sup> 0.18 m <sup>3</sup>
<b>H</b>	10"	25 cm	<b>Nett</b>	37 lb 17 kg
			<b>Gross</b>	51 lb 23 kg

FRAME

Premium Teak | Smooth (F24)

TABLE TOP & SIDE TRAY

HPL (High Pressure Laminate)



**HACIENDA Armless**

HAC01

<b>W</b> 33.5"	85 cm	Unit	1 / Box	
<b>D</b> 33.5"	85 cm	Volume	20 ft <sup>3</sup>	0.56 m <sup>3</sup>
<b>H</b> 27.5"	70 cm	Nett	37 lb	17 kg
<b>SH</b> 16"	40 cm	Gross	49 lb	22 kg



**HACIENDA Corner**

HAC02

<b>W</b> 33.5"	85 cm	Unit	1 / Box	
<b>D</b> 33.5"	85 cm	Volume	20 ft <sup>3</sup>	0.56 m <sup>3</sup>
<b>H</b> 27.5"	70 cm	Nett	42 lb	19 kg
<b>SH</b> 16"	40 cm	Gross	53 lb	24 kg



**HACIENDA Ottoman**

HAC03

<b>W</b> 33.5"	85 cm	Unit	1 / Box	
<b>D</b> 33.5"	85 cm	Volume	13 ft <sup>3</sup>	0.36 m <sup>3</sup>
<b>H</b> 16"	40 cm	Nett	33 lb	15 kg
		Gross	44 lb	20 kg



**HACIENDA Right Hand Sectional (Teak)**

HAC05

<b>W</b> 98.5"	250 cm	Unit	1 / Box	
<b>D</b> 33.5"	85 cm	Volume	57 ft <sup>3</sup>	1.61 m <sup>3</sup>
<b>H</b> 27.5"	70 cm	Nett	99 lb	45 kg
<b>SH</b> 16"	40 cm	Gross	119 lb	54 kg



**HACIENDA Left Hand Sectional (Teak)**

HAC04

<b>W</b> 98.5"	250 cm	Unit	1 / Box	
<b>D</b> 33.5"	85 cm	Volume	57 ft <sup>3</sup>	1.61 m <sup>3</sup>
<b>H</b> 27.5"	70 cm	Nett	99 lb	45 kg
<b>SH</b> 16"	40 cm	Gross	119 lb	54 kg



**HACIENDA Right Hand Sectional with Arm (Teak)**

HAC07

<b>W</b> 106"	270 cm	Unit	Crate	
<b>D</b> 33.5"	85 cm	Volume	90 ft <sup>3</sup>	2.56 m <sup>3</sup>
<b>H</b> 27.5"	70 cm	Nett	108 lb	49 kg
<b>SH</b> 16"	40 cm	Gross	311 lb	141 kg
<b>AH</b> 22"	55 cm			



**HACIENDA Left Hand Sectional with Arm (Teak)**

HAC06

<b>W</b> 106"	270 cm	Unit	Crate	
<b>D</b> 33.5"	85 cm	Volume	90 ft <sup>3</sup>	2.56 m <sup>3</sup>
<b>H</b> 27.5"	70 cm	Nett	108 lb	49 kg
<b>SH</b> 16"	40 cm	Gross	311 lb	141 kg
<b>AH</b> 22"	55 cm			



**HACIENDA Sectional Table (Teak)**

HAC18

<b>L</b> 33.5"	85 cm	Unit	1 / Box	
<b>W</b> 33.5"	85 cm	Volume	6 ft <sup>3</sup>	0.17 m <sup>3</sup>
<b>H</b> 10"	25 cm	Nett	33 lb	15 kg
		Gross	44 lb	20 kg



SUGGESTED CONFIGURATIONS



HACCO-1A **HACIENDA Configuration 1A (Teak)**

HAC05 + HAC02 + HAC04

HACCO-11A **HACIENDA Configuration 11A (HPL)**

HAC21 + HAC02 + HAC20



HACCO-1B **HACIENDA Configuration 1B (Teak)**

HAC05 + HAC03 + HAC04

HACCO-11B **HACIENDA Configuration 11B (HPL)**

HAC21 + HAC03 + HAC20

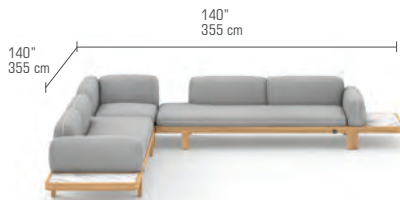

HACCO-2A **HACIENDA Configuration 2A (Teak)**

HAC07 + HAC02 + HAC06

HACCO-12A **HACIENDA Configuration 12A (HPL)**

HAC23 + HAC02 + HAC22



HACCO-2B **HACIENDA Configuration 2B (Teak)**

HAC07 + HAC03 + HAC06

HACCO-12B **HACIENDA Configuration 12B (HPL)**

HAC23 + HAC03 + HAC22

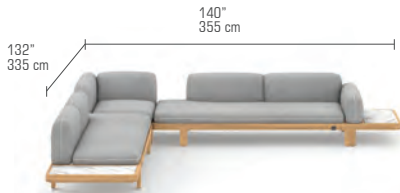

HACCO-3A **HACIENDA Configuration 3A (Teak)**

HAC05 + HAC02 + HAC06

HACCO-13A **HACIENDA Configuration 13A (HPL)**

HAC21 + HAC02 + HAC22

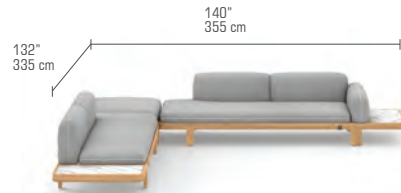

HACCO-3B **HACIENDA Configuration 3B (Teak)**

HAC05 + HAC03 + HAC06

HACCO-13B **HACIENDA Configuration 13B (HPL)**

HAC21 + HAC03 + HAC22



HACCO-4A **HACIENDA Configuration 4A (Teak)**

HAC07 + HAC02 + HAC04

HACCO-14A **HACIENDA Configuration 14A (HPL)**

HAC23 + HAC02 + HAC20



HACCO-4B **HACIENDA Configuration 4B (Teak)**

HAC07 + HAC03 + HAC04

HACCO-14B **HACIENDA Configuration 14B (HPL)**

HAC23 + HAC03 + HAC20

## SUGGESTED CONFIGURATIONS



HACCO-5 **HACIENDA Configuration 5 (Teak)**

HAC05 + HAC02 + HAC01 + HAC06

HACCO-15 **HACIENDA Configuration 15 (HPL)**

HAC21 + HAC02 + HAC01 + HAC22



HACCO-6 **HACIENDA Configuration 6 (Teak)**

HAC07 + HAC01 + HAC02 + HAC04

HACCO-16 **HACIENDA Configuration 16 (HPL)**

HAC23 + HAC01 + HAC02 + HAC20



HACCO-7 **HACIENDA Configuration 7 (Teak)**

HAC03 + HAC02 + HAC01 + HAC04

HACCO-17 **HACIENDA Configuration 17 (HPL)**

HAC03 + HAC02 + HAC01 + HAC20

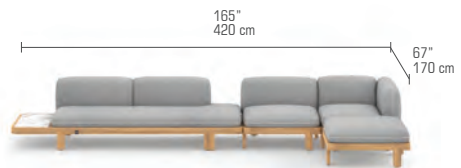

HACCO-8 **HACIENDA Configuration 8 (Teak)**

HAC05 + HAC01 + HAC02 + HAC03

HACCO-18 **HACIENDA Configuration 18 (HPL)**

HAC21 + HAC01 + HAC02 + HAC03

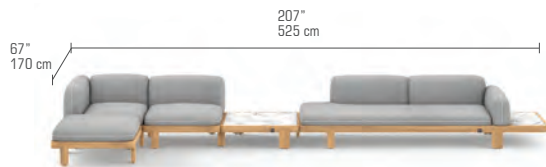

HACCO-9 **HACIENDA Configuration 9 (Teak)**

HAC03 + HAC02 + HAC01 + HAC18 + HAC06

HACCO-19 **HACIENDA Configuration 19 (HPL)**

HAC03 + HAC02 + HAC01 + HAC19 + HAC22

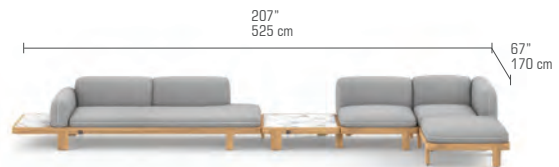

HACCO-10 **HACIENDA Configuration 10 (Teak)**

HAC07 + HAC18 + HAC01 + HAC02 + HAC03

HACCO-20 **HACIENDA Configuration 20 (HPL)**

HAC23 + HAC19 + HAC01 + HAC02 + HAC03



HACCO-21 **HACIENDA Configuration 21 (Teak)**

HAC03 + HAC02 + HAC06

HACCO-31 **HACIENDA Configuration 31 (HPL)**

HAC03 + HAC02 + HAC22



HACCO-22 **HACIENDA Configuration 22 (Teak)**

HAC07 + HAC02 + HAC03

HACCO-32 **HACIENDA Configuration 32 (HPL)**

HAC23 + HAC02 + HAC03



**HACIENDA Sunbed Sling**

HAC15

**L** 79" | 201 cm  
**W** 33" | 83 cm  
**H** 36" | 92 cm  
**SH** 13" | 33 cm

Unit	1 / Box	
Volume	24 ft3	0.68 m3
Nett	60 lb	27 kg
Gross	86 lb	39 kg

**Optional Headrest - HACIENDA Sunbed Sling**

CUHAC15

**Thickness** 1.5" | 4 cm

**FRAME**

Premium Teak | Smooth (F24)

**SLING**

All Slings



**HACIENDA Sunbed Teak**

HAC14

**L** 81" | 205 cm  
**W** 30" | 77 cm  
**H** 33.5" | 85 cm  
**SH** 11" | 27 cm

Unit	1 / Box	
Volume	23 ft3	0.64 m3
Nett	71 lb	32 kg
Gross	93 lb	42 kg



**Optional Cushion - HACIENDA Sunbed Teak**

CUHAC14

**Thickness** 2" | 6 cm

**FRAME**

Premium Teak | Smooth (F24)



**HACIENDA Large Coffee Table (Teak Top)\***  
HAC08

Ø	39.5"   100 cm	Unit	1 / Box	
H	12"   30 cm	Volume	13 ft <sup>3</sup>	0.37 m <sup>3</sup>
		Nett	37 lb	17 kg
		Gross	49 lb	22 kg



**HACIENDA Large Coffee Table (HPL Top)\*\***  
HAC11

Ø	39.5"   100 cm	Unit	1 / Box	
H	12"   30 cm	Volume	14 ft <sup>3</sup>	0.39 m <sup>3</sup>
		Nett	42 lb	19 kg
		Gross	55 lb	25 kg



**HACIENDA Small Coffee Table (Teak Top)\***  
HAC09

Ø	27.5"   70 cm	Unit	1 / Box	
H	16"   40 cm	Volume	8.5 ft <sup>3</sup>	0.24 m <sup>3</sup>
		Nett	26 lb	12 kg
		Gross	35 lb	16 kg



**HACIENDA Small Coffee Table (HPL Top)\*\***  
HAC12

Ø	27.5"   70 cm	Unit	1 / Box	
H	16"   40 cm	Volume	9 ft <sup>3</sup>	0.25 m <sup>3</sup>
		Nett	29 lb	13 kg
		Gross	40 lb	18 kg



**HACIENDA Side Table (Teak Top)\***  
HAC10

Ø	18"   45 cm	Unit	1 / Box	
H	20"   50 cm	Volume	3.5 ft <sup>3</sup>	0.10 m <sup>3</sup>
		Nett	15 lb	7 kg
		Gross	22 lb	10 kg



**HACIENDA Side Table (HPL Top)\*\***  
HAC13

Ø	18"   45 cm	Unit	1 / Box	
H	20"   50 cm	Volume	4 ft <sup>3</sup>	0.11 m <sup>3</sup>
		Nett	18 lb	8 kg
		Gross	24 lb	11 kg

FRAME

Premium Teak | Smooth (F24)

TABLE TOP

\*Premium Teak | Smooth (T24)

\*\*HPL (High Pressure Laminat)

